

## Description

The DFC2071P6 is an Uni-directional TVS diode, utilizing leading monolithic silicon technology to provide fast re-sponse time and low ESD clamping voltage, making this device an ideal solution for protecting voltage sensitive data and power line. The DFC2071P6 complies with the IEC 61000-4-2 (ESD) with  $\pm 30\text{kV}$  air and  $\pm 30\text{kV}$  contact discharge. It is assembled into an ultra-small 1.6x1.0x0.5mm lead-free DFN package. The small size and high ESD surge protection make DFC2071P6 an ideal choice to protect cell phone, digital cameras, audio players and many other portable applications.

## Mechanical Characteristics

- ◆ Package: DFN1610-2
- ◆ Case Material: "Green" Molding Compound.
- ◆ Moisture Sensitivity: Level 3 per J-STD-020
- ◆ Terminal Connections: See Diagram Below
- ◆ Marking Information: See Below

## Dimensions and Pin Configuration

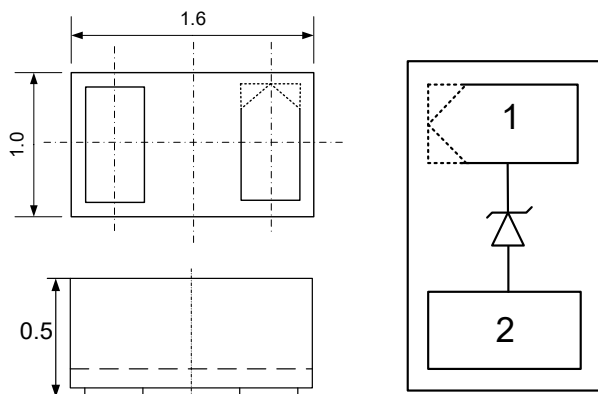

Package Dimensions (mm)      Circuit and Pin Schematic

## Features

- ◆ Small package: 1.6 x1.0 x0.5mm
- ◆ Protects one data or power line
- ◆ Operating voltage: 20V
- ◆ High peak pulse current capability
- ◆ Ultra low clamping voltage
- ◆ 2-pin leadless package
- ◆ Complies with following standards:
  - IEC 61000-4-2 (ESD) immunity test
  - Air discharge:  $\pm 30\text{kV}$
  - Contact discharge:  $\pm 30\text{kV}$
- ◆ RoHS Compliant

## Applications

- ◆ Mobile Phones and Accessories
- ◆ Battery Protection
- ◆ USB VBus
- ◆ Power Line Protection
- ◆ Hand Held Portable Applications

## Marking Information

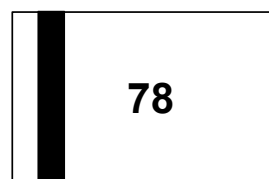

78= Device Marking Code  
Bar denotes Cathode

## Ordering Information

Part Number	Marking	Packaging	Reel Size
DFC2071P6	78	3000/Tape & Reel	7 inch

### **Absolute Maximum Ratings ( $T_A=25^{\circ}\text{C}$ unless otherwise specified)**

Parameter	Symbol	Value	Unit
Peak Pulse Power(8/20 $\mu\text{s}$ )	Ppk	500	W
ESD per IEC 61000-4-2 (Air) ESD per IEC 61000-4-2 (Contact)	VESD	$\pm 30$ $\pm 30$	kV
Operating Temperature Range	TJ	-55 to +125	$^{\circ}\text{C}$
Storage Temperature Range	Tstg	-55 to +150	$^{\circ}\text{C}$

### **Electrical Characteristics ( $T_A=25^{\circ}\text{C}$ unless otherwise specified)**

Parameter	Symbol	Min	Typ	Max	Unit	Test Condition
Reverse Working Voltage	VRWM			20	V	
Breakdown Voltage	VBR	21			V	$I_T = 1\text{mA}$
Reverse Leakage Current	$I_R$			1	$\mu\text{A}$	VRWM = 20V
Forward Voltage	VF			1.2	V	$I_F = 10\text{mA}$
Peak Pulse Current	IPP			20	A	$t_p = 8/20\mu\text{s}$
Clamping Voltage	VC		23		V	IPP=1A (8x20 $\mu\text{s}$ pulse),pin1 to pin2
Clamping Voltage	VC		25		V	IPP=20A (8x20 $\mu\text{s}$ pulse),pin1 to pin2
Junction Capacitance	CJ		230		pF	VR = 0V, f = 1MHz

**Typical Performance Characteristics (TA=25°C unless otherwise Specified)**

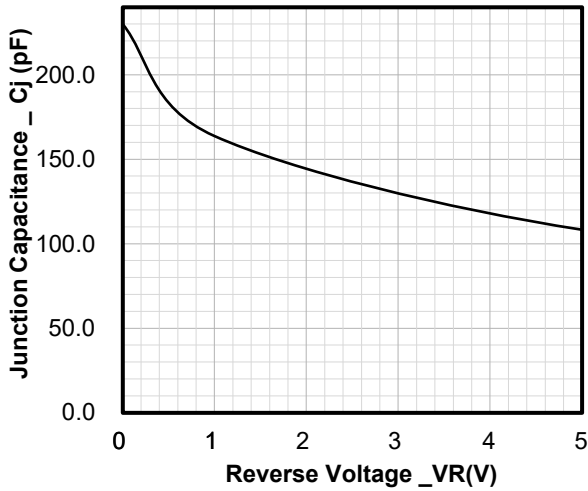

Junction Capacitance vs. Reverse Voltage

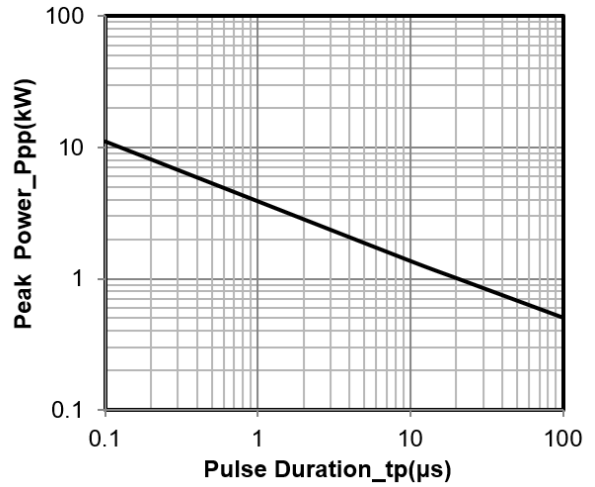

Peak Pulse Power vs. Pulse Time

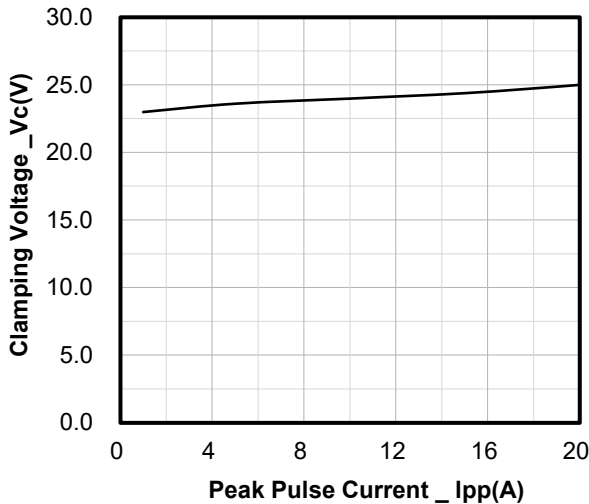

Clamping Voltage vs. Peak Pulse Current

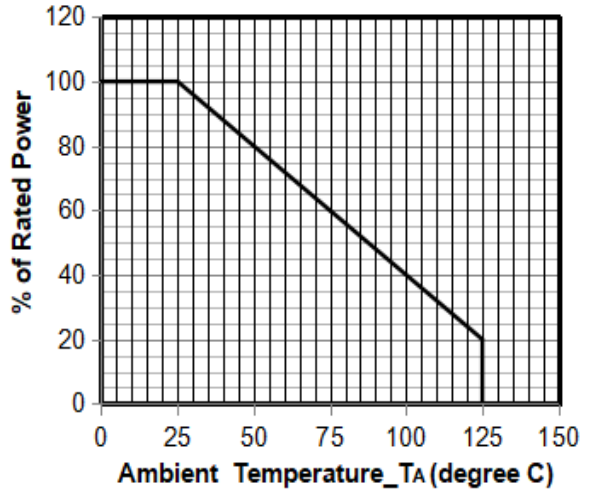

Power Derating Curve

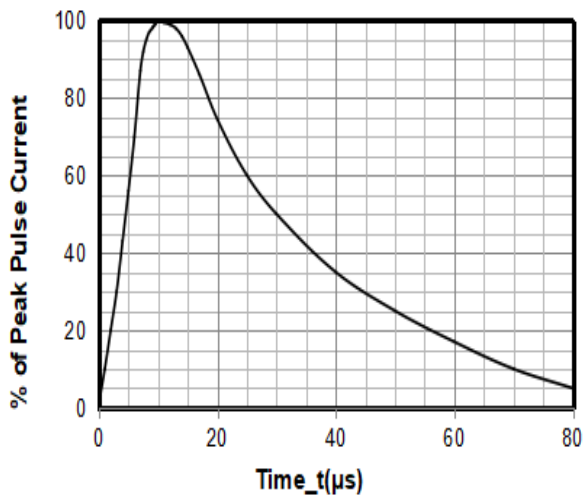

8 X 20μs Pulse Waveform

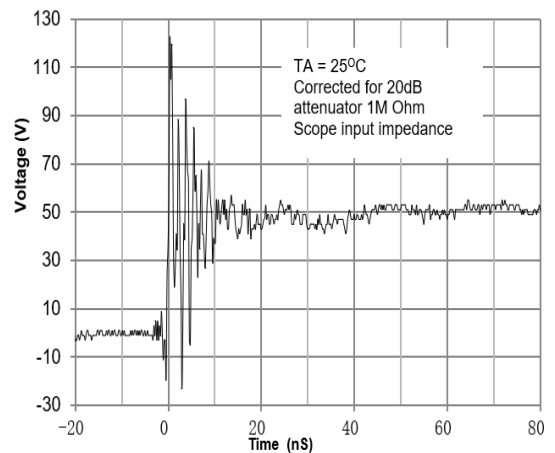

ESD Clamping Voltage

8 kV Contact per IEC61000-4-2

